



Titan3 and Target2 Chromatography Syringe Filters

Performance filtration solutions
for chromatographic applications



Sample preparation is a key stage in successful chromatography

The high quality Thermo Scientific™ **Titan3™** and **Target2™** syringe filters ensure reliable elimination of both particles and micro organisms in the sample preparation process, providing consistent and reliable experimental results for a range of samples and applications. Titan3 and Target2 syringe filters protect chromatography columns by preventing the accumulation of fine particles in the column, which forms premature blockages.

Both Titan3 and Target2 syringe filters provide high-quality filtration solutions

- Sample preparation for HPLC and UHPLC analysis
- Protect columns and extend column lifetimes
- Low sample volume compatibility
- High integrity sample preparation

The premium Titan3 syringe filter range provides even higher levels of confidence

- Color coding for easy identification and selection of the correct membrane and pore size
- 30 mm products pressure rated to 120 psi/15 bar
- Integrated prefilter options for enhanced removal of particulates



Operating guidance

Take sample from vial

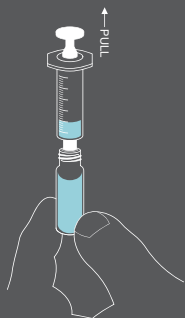

Twist syringe clockwise

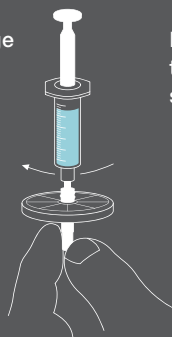

Push sample through syringe filter

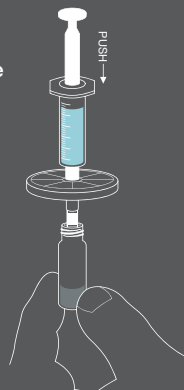

Replace cap on vial and place in autosampler

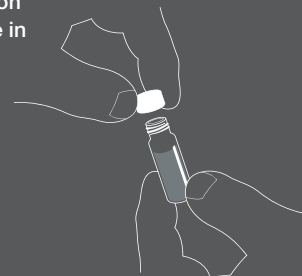

Syringe filter selection

How to choose the correct filter for your chromatographic application

1 Sample volume

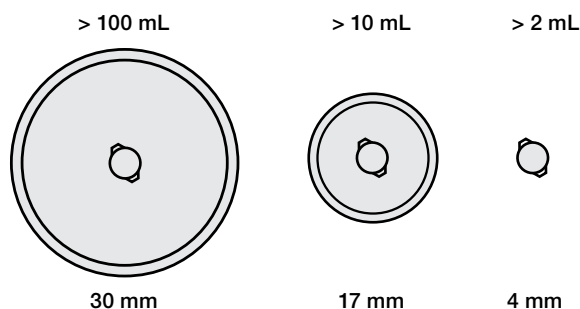

2 Size and amount of particulates in the sample

Sample particle size	< 0.5 µm	< 2.0 µm	> 5 µm
HPLC column particle size	> 3.0 µm	> 3.0 µm	High particle load
	↓	↓	↓
Filter pore size	0.22 µm	0.45 µm	GMF

3 Membrane compatibility with sample type and technique

Sample Type	Technique
Standard HPLC samples/solvents	Nylon (NY)
	Regenerated Cellulose (RC)
	Polyvinylidene Fluoride (PVDF)
Standard GC samples/solvents	Polytetrafluoroethylene (PTFE)
UV spectrometry	PVDF
Capillary electrophoresis	Polyethersulfone (PES)
High particle load	Glass MicroFiber (GMF)
Protein analysis	PVDF
Protein removal	GMF
Trace metals	PES
Aggressive and nonpolar solvent	PTFE
Biological sample preparation	Cellulose Acetate (RC)
Protein and peptide samples, general HPLC	Polypropylene (PP)
Highly particulated samples	Glass MicroFiber (GMF)

Syringe filter unit specification

	Titan3			Target2		
	4 mm	17 mm	30 mm	4 mm	17 mm	30 mm
Housing	Polypropylene with integral colour-coded sealing ring	Polypropylene with integral colour-coded sealing ring	Polypropylene with integral colour-coded sealing ring	Polypropylene	Polypropylene	Polypropylene
Filtration area	0.125 cm ²	1.6 cm ²	4.9 cm ²	0.125 cm ²	1.6 cm ²	4.9 cm ²
Maximum pressure	5.5 BAR	8 BAR	15 BAR	5.5 BAR	8 BAR	10 BAR
Residual volume	< 15 µL with air purge	< 35 µL with air purge	< 157 µL with air purge	< 15 µL with air purge	< 35 µL with air purge	< 157 µL with air purge
Dimensions	8 mm × 20.7 mm	20.5 mm × 24.5 mm	34 mm × 24.5 mm	8 mm × 20.7 mm	20.5 mm × 24.5 mm	34 mm × 24.5 mm
Flow direction	Inlet-outlet only	Inlet-outlet only	Inlet-outlet only	Inlet-outlet only	Inlet-outlet only	Inlet-outlet only
Inlet	Female luer lock tab	Female luer screw	Female luer screw	Female luer lock tab	Female luer screw	Female luer screw
Outlet	Male luer slip	Male luer slip	Male luer slip	Male luer slip	Male luer slip	Male luer slip
Pre-filter	N	Selected membranes	Selected membranes	N	N	Selected membranes

Polypropylene syringe filter housings meet the requirements of 21 CFR 177.1520

4 Membrane solvent compatibility

	Chemicals	NY	PTFE	PVDF	RC	PES	GMF	PP	CA
Acids	Acetic, Glacial	LC	C	C	C	C	C	C	IC
	Acetic, 25%	C	C	C	C	C	C	C	C
	Hydrochloric, Concentrated	IC	C	C	IC	C	C	C	IC
	Hydrochloric, 25%	IC	C	C	IC	C	C	C	IC
	Sulfuric, Concentrated	IC	C	IC	IC	IC	C	C	IC
	Sulfuric, 25%	IC	C	C	LC	C	C	C	IC
	Nitric, Concentrated	IC	C	C	IC	IC	LC	C	IC
	Nitric, 25%	IC	C	C	IC	C	LC	C	IC
	Phosphoric, 25%	IC	C	ND	LC	ND	ND	C	C
	Formic, 25%	IC	C	ND	C	ND	C	C	LC
Trichloroacetic, 10%	IC	C	ND	C	ND	ND	C	C	
Alcohols	Methanol, 98%	C	C	C	C	C	C	C	C
	Ethanol, 98%	C	C	C	C	C	C	C	C
	Ethanol, 70%	LC	C	C	C	C	C	C	C
	Isopropanol	C	C	C	C	C	C	C	C
	n-Propanol	C	C	C	C	C	C	C	C
	Amyl Alcohol (Butanol)	C	C	C	C	C	C	C	C
	Benzyl Alcohol	C	C	C	C	ND	IC	C	LC
	Ethylene Glycol	C	C	C	C	C	C	C	C
	Propylene Glycol	C	C	C	C	C	C	C	LC
	Glycerol	C	C	C	C	C	C	C	C
Amines and Amides	Dimethyl Formamide	LC	C	IC	LC	IC	C	C	IC
	Diethylacetamide	C	C	ND	C	ND	C	ND	IC
	Triethanolamine	C	C	ND	C	ND	ND	ND	C
	Aniline	ND	C	ND	C	ND	ND	ND	IC
	Pyridine	C	C	IC	C	IC	C	IC	IC
	Acetonitrile	C	C	C	C	LC	C	C	IC
Esters	Ethyl Acetate/Methyl Acetate	C	C	C	C	IC	C	LC	IC
	Amyl Acetate/Butyl Acetate	C	C	IC	C	IC	C	LC	LC
	Propyl Acetate	C	C	IC	C	IC	ND	LC	LC
	Propylene Glycol Acetate	ND	C	ND	C	IC	ND	C	IC
	2-Ethoxyethyl Acetate	ND	C	ND	C	IC	ND	ND	LC
	Methyl Cellulosolve	ND	C	ND	C	IC	C	C	IC
	Benzyl Benzoate	C	C	ND	C	IC	ND	ND	C
	Isopropyl Myristate	C	C	ND	C	IC	ND	ND	C
Tricresyl Phosphate	ND	C	ND	C	IC	ND	ND	C	
Halogenated Hydrocarbons	Methylene Chloride	LC	C	C	C	IC	C	LC	IC
	Chloroform	C	C	C	C	IC	C	LC	IC
	Trichloroethylene	C	C	C	C	IC	C	C	C
	Chlorobenzene	C	C	C	C	LC	C	C	C
	Freon	C	C	C	C	LC	C	C	C
	Carbon Tetrachloride	C	C	C	C	IC	C	LC	LC
Hydrocarbons	Hexane/Xylene	C	C	C	C	IC	C	IC	C
	Toluene/Benzene	C	C	C	C	IC	C	IC	C
	Kerosene/Gasoline	C	C	C	C	LC	ND	LC	C
	Tetralin/Decalin	ND	C	C	C	ND	ND	ND	C
Ketones	Acetone	C	C	IC	C	IC	C	C	IC
	Cyclohexanone	C	C	IC	C	IC	C	C	IC
	Methyl Ethyl Ketone	C	C	LC	C	IC	C	LC	LC
	Isopropylacetone	C	C	IC	C	IC	C	ND	C
	Methyl Isobutyl Ketone	ND	C	LC	C	IC	C	LC	ND
Organic Oxides	Ethyl Ether	C	C	C	C	C	ND	LC	C
	Dioxane	C	C	LC	C	IC	C	C	IC
	Tetrahydrofuran	C	C	LC	C	IC	C	C	IC
	Triethanolamine	C	C	ND	C	ND	ND	ND	C
	Dimethylsulfoxide (DMSO)	C	C	IC	C	IC	C	C	IC
	Isopropyl Ether	ND	C	C	C	C	ND	C	C
Miscellaneous	Phenol, Aqueous Solution, 10%	ND	C	LC	IC	IC	C	C	IC
	Formaldehyde Aqueous Solution, 30%	C	C	C	LC	C	C	C	C
	Hydrogen Peroxide, 30%	C	C	ND	C	ND	ND	ND	C
	Silicone Oil/Mineral Oil	ND	C	C	C	C	C	C	C
	Ammonium Hydroxide, 25%	C	C	LC	LC	C	C	C	C
Sodium Hydroxide, 3N	C	C	C	LC	C	IC	C	IC	

C Compatible
LC Limited Compatibility (Membrane may swell and shrink)

IC Incompatible (Not Recommended)
ND No Compatibility Data Currently Available

Syringe filter membrane specification



PVDF (Hydrophilic/Hydrophobic) syringe filters

Superior membrane quality for HPLC. Hydrophilic PVDF syringe filters do not require pre-wetting for use with aqueous samples. Hydrophobic PVDF filters require pre-wetting with an alcohol before use with aqueous samples.

- Low non-specific binding with exceptional chemical resistance
- Hydrophilic membrane provides excellent flow rates and low binding coefficients
- Certified for chromatographic performance
- Compatible with a wide range of aqueous and organic-based sample environments
- Recommended for HPLC and UHPLC

PVDF syringe filters have a well defined pore structure, giving effective retention of particles without excessive pore blockage. Compatible with aqueous and most organic solvents. They are excellent general filters for HPLC and organic solvent sample clean up.

Specifications

Membrane:	HPLC certified PVDF
Max. operating temperature:	100 °C
Housing:	Medical grade, virgin polypropylene
Pre-filter:	Binder free glass microfiber 1 µm (0.20 µm only)
Porosities:	0.20 µm, 0.45 µm
Autoclave:	Sterilize by dry heat at 121 °C for 15 minutes

Applications

- HPLC and organic solvent sample preparation and clean up
- Protein based samples with high non-specific binding
- Environmental water samples

Chemical Incompatibilities

- DMF, DMSO, MEK, acetone and most caustic solutions > 6N

Regenerated cellulose syringe filters

Superior chemical resistance, optimized for biological sample recoveries.

- Hydrophilic membrane provides excellent flow rates and extremely low binding coefficients
- Superior choice for biological assays, gel capsule dissolution testing, protein sample matrixes
- Compatible with a wide range of aqueous and organic-based sample environments
- Recommended for reverse phase and normal phase HPLC

Regenerated cellulose syringe filters are ideally suited for almost any laboratory procedure, from HPLC sample preparation to dissolution sample testing. Regenerated cellulose possesses superior chemical resistance in either aqueous or organic-based sample environments. Its extremely low biological-based binding coefficient is ideally suited for maximum sample recoveries of biological-based assays. Regenerated cellulose contains no binders, surfactants or wetting agents to assure minimal extractables in analytical procedures.

Specifications

Membrane cellulose:	HPLC certified regenerated
Protein binding:	< 5 µg/cm ²
Porosities:	0.20 µm, 0.45 µm
Autoclave:	Sterilize by dry heat at 121 °C for 15 minutes
Pre-filter (if fitted):	GMF 1 µm

Applications

- HPLC and organic solvent sample preparation and clean up
- Dissolution sample analysis, especially high-binding tablets or capsules
- Protein-based samples with high non-specific binding
- Sample analysis which require maximum recoveries
- Analysis requiring low non-specific binding over a wide pH range

Chemical Incompatibilities

- Sulfuric acid, hydrochloric acid, phosphoric acid or nitric acid > 25%, DMF, phenol

Cellulose acetate syringe filters

For filtering of aqueous solutions or biological samples.

- Hydrophilic membrane provides excellent flow rates and extremely low protein-binding coefficients
- Superior choice for biological assays, gel capsule dissolution testing, protein sample matrixes
- Recommended for aqueous HPLC

A physically strong membrane which can be used with heated liquids.

Specifications

Membrane:	HPLC certified cellulose acetate
Max. operating temperature:	110 °C
Protein binding:	< 24 µg/cm ²
Porosities:	0.20 µm, 0.45 µm
Autoclave:	Sterilize by dry heat at 121 °C for 15 minutes

Applications

- Protein-based samples with high non-specific binding
- Sample analysis which require maximum recoveries

Chemical Incompatibilities

- Acids, NaOH, dichloromethane, chloroform, ketones, DMSO, THF

Polypropylene syringe filters

Chemically resistant membrane with low protein binding.

- Hydrophilic membrane for aqueous or organic sample matrixes
- Use with protein or peptide-based assays

The hydrophilic polypropylene membrane is easily wetted with water and does not require pre-treatment with alcohols. Compatible with biological samples. Do not use with strong organic solvents, especially aromatic and chlorinated solvents.

Specifications

Membrane:	Hydrophilic polypropylene
Max. operating temperature:	110 °C
Housing:	Medical grade, virgin polypropylene
Porosities:	0.20 µm, 0.45 µm

Applications

- Protein or peptide-based assays
- General HPLC analysis

Chemical Incompatibilities

- Hexane, toluene, benzene, limited resistance to dichloromethane and chloroform



Glass microfiber (GMF) syringe filters

For large particulate removal.

- Increased sample throughput
- Low extraction neutral borosilicate glass
- For use with viscous or particle-laden samples

GMF filters are available in a range of porosities.

Specifications

Membrane:	Binder free glass microfiber
Max. operating temperature:	110 °C
Housing:	Medical grade, virgin polypropylene
Porosities:	0.7 µm, 1.2 µm, 3.1 µm
Autoclave:	Sterilize by dry heat at 121 °C for 15 minutes

Applications

- Clarification
- Pre-filtering of suspensions

Chemical Incompatibilities

- Limited resistance with ammonia, NaOH and KOH solutions



PTFE (Hydrophobic and Hydrophilic) syringe filters

Excellent chemical resistance for use with organic matrices.

- Excellent flow rates and high loading capacities
- Exceptional temperature stability
- Organic solvent recommended
- Hydrophilic PTFE can be used for the same application but no pre-wetting of the membrane is required

PTFE syringe filters are applicable for filtration of gaseous or organic solvent-based samples. Both membrane types exhibits broad chemical resistance and unsurpassed temperature stability to address aggressive sample matrixes and extreme temperature situations. The hydrophobic PTFE filter can be utilized as a moisture barrier in venting applications.

PTFE hydrophobic membranes require pre-treatment with alcohol before being suitable for aqueous or high aqueous/organic samples. Do not use directly with aqueous solutions.

Specifications

Membrane:	HPLC certified PTFE, w/polypropylene support
Max. operating temperature:	110 °C
Housing:	Medical grade, virgin polypropylene
Porosities:	0.20 µm, 0.45 µm, 1 µm
Autoclave:	Sterilize by dry heat at 121 °C for 15 minutes

Applications

- HPLC and organic solvent sample preparation and clean up
- Dissolution sample analysis
- General sample preparation prior to analytical analysis
- Elevated temperature samples, caustic or acidic solutions

Chemical Incompatibilities

- Perchloric acid
- Methylene chloride (limited exposure)
- Dioxane, DMF, formic acid > 50%
- Aqueous-based sample matrix (unless filter is pre-wetted with an alcohol)



Nylon syringe filters

Membrane of choice for analytical applications.

- Naturally hydrophilic with broad chemical resistance
- Excellent flow rates and high-throughput loading
- HPLC recommended

Hydrophilic nylon is extremely well suited for aqueous or organic sample preparation and HPLC, GC or dissolution sample analysis. Due to its excellent flow characteristics and mechanical stability, nylon offers the best combination of physical parameters to meet the most stringent analytical needs.

Specifications

Membrane:	HPLC certified nylon
Max. operating temperature:	100 °C
Housing:	Medical grade, virgin polypropylene
Porosities:	0.20 µm, 0.45 µm, 1.5 µm, 5 µm
Autoclave:	Sterilize by dry heat at 121 °C for 15 minutes

Applications

- HPLC and organic solvent sample preparation and clean up
- Dissolution sample analysis
- General sample preparation prior to analytical analysis
- Mixed sample matrix of aqueous or organic dissolved analytes

Chemical Incompatibilities

- Acids > 1N

Halogenated solvents

- Proteineous samples with high non-specific binding affinities



PES syringe filters—Ion chromatography (IC) certified

Precise results in sensitive analysis of ionic analytes.

- Certified for low-level IC interference by ICP analysis
- Hydrophilic membrane provides excellent flow rates and low binding coefficients
- Low affinity for binding drugs, ideal for dissolution testing procedures

This hydrophilic polymer has excellent cleanliness and is compatible with a wide range of solvents. It is the membrane of choice for ion chromatography applications.

Specifications

Membrane:	ICP Certified PES (PolyEtherSulfone)
Max. operating temperature:	100 °C
Housing:	Medical grade, virgin polypropylene
Pre-filter:	Binder-free glass microfiber pre-filter (0.20 µm only)
Porosities:	0.20 µm, 0.45 µm
Autoclave:	Sterilize by dry heat at 121 °C for 15 minutes

Applications

- IC sample preparation and analysis
- Dissolution testing

Chemical Incompatibilities







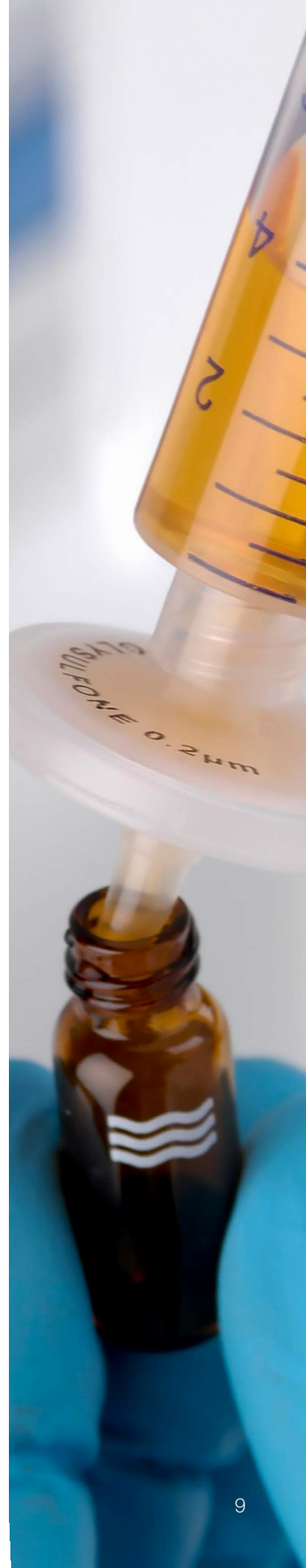













































- Protein-based samples in aqueous solutions
- Concentrated acids, chloromethane, chloroform, hexane, acetone, MEK, THF, DMSO

Analysis results (ppb)

Analyte	Method detection level (ppb)	0.2 µm PES	0.45 µm PES
Bromide	< 100	< MDL	< MDL
Chloride	20	< MDL	< MDL
Fluoride	20	< MDL	< MDL
Nitrate as N	50	< MDL	< MDL
Orthophosphate as P	< 100	< MDL	< MDL
Sulfate	< 100	< MDL	< MDL
Barium	2	< MDL	< MDL
Calcium	10	39.9	58.9
Potassium	50	80	70
Magnesium	20	< MDL	< MDL
Sodium	20	80.6	63



Cross reference syringe filter units

	Thermo Scientific	Thermo Scientific	Ring color		
	Titan3 Product code	Target2 Product code			
4 mm Syringe Filters	4 mm syringe filter 0.45 µm nylon	13416906	11985693	Transparent Green 	
	4 mm syringe filter 0.2 µm polypropylene		10638915	N/A	
	4 mm syringe filter 0.45 µm cellulose acetate		10199524	N/A	
	4 mm syringe filter 0.2 µm cellulose acetate	13436906	10058184	Light Green 	
	4 mm syringe filter 0.2 µm nylon	13416896	10351115	Opaque Medium Yellow 	
	4 mm syringe filter 0.45 µm PTFE	13577770	10007354	Transparent Yellow 	
	4 mm syringe filter 0.2 µm PTFE	13517760	10055984	Transparent Blue 	
	4 mm syringe filter 0.45 µm PVDF	13446906	10026174	Red 	
	4 mm syringe filter 0.2 µm PVDF	13406896	10576575	Black 	
	4 mm syringe filter 0.45 µm regenerated cellulose	13527800	10036364	Light Brown 	
	4 mm syringe filter 0.2 µm regenerated cellulose	13557790	10586005	Granite 	
	4 mm syringe filter 0.45 µm polypropylene		10586575	N/A	
	17 mm Syringe Filters	17 mm syringe filter 0.45 µm nylon	13456906	10301345	Transparent Green 
		17 mm syringe filter 0.2 µm polypropylene	13436896	10391205	Royal Blue 
17 mm syringe filter 0.45 µm PES for Ion chromatography		13496906	10446684	Orange/Yellow 	
17 mm syringe filter 0.45 µm cellulose acetate		13466906	10713016	Transparent Orange 	
17 mm syringe filter 0.2 µm cellulose acetate		13426896	10109564	Light Green 	
17 mm syringe filter 0.2 µm PES for Ion chromatography		13446896	10017364	Dark Gray 	
17 mm syringe filter 0.2 µm nylon		13486796	10127794	Light Purple 	
17 mm syringe filter 0.45 µm PTFE (Hydrophobic)		13527780	10353015	Transparent Yellow 	
17 mm syringe filter 0.2 µm PTFE (Hydrophobic)		13567760	10187834	Transparent Blue 	
17 mm syringe filter 0.45 µm PTFE (Hydrophobic)		15217498		Purple 	
17 mm syringe filter 0.2 µm PTFE (Hydrophobic)		16227311		Green 	
17 mm syringe filter 0.45 µm PVDF		13486906	10269554	Red 	
17 mm syringe filter 0.2 µm PVDF		13456896	10774247	Black 	
17 mm syringe filter 0.45 µm regenerated cellulose		13517800	10027124	Light Brown 	
17 mm syringe filter 0.2 µm regenerated cellulose		13577790	10037124	Granite 	
17 mm syringe filter 0.45 µm polypropylene		13476906	10549755	White 	
30 mm Syringe Filters	30 mm syringe filter 0.45 µm nylon with pre-filter	13406916	10631416	Transparent Green 	
	30 mm syringe filter 0.2 µm polypropylene	13406906	10065734	Royal Blue 	
	30 mm syringe filter 5.0 µm PTFE			N/A	
	30 mm syringe filter 1.25 µm nylon	13486886	10458304	Opaque Medium Yellow 	
	30 mm syringe filter 1.0 µm PTFE	12622613	10117614	Dark Blue 	
	30 mm syringe filter 0.45 µm PES for Ion chromatography	13426916	10210905	Orange/Yellow 	
	30 mm syringe filter 0.45 µm cellulose acetate	13416916	10331075	Transparent Orange 	
	30 mm syringe filter 0.2 µm cellulose acetate	13466896	10159494	Light Green 	
	30 mm syringe filter 0.2 µm PES for Ion chromatography with pre-filter	13486896	10290855	Dark Gray 	
	30 mm syringe filter 0.7 µm glass micro fiber	13416786	10353465	Amber 	
	30 mm syringe filter 1.2 µm glass micro fiber	13406786	10352575	Orange 	
	30 mm syringe filter 0.25 µm nylon	13456916	10085634	Pink 	
	30 mm syringe filter 3.1 µm glass micro fiber	13426906	10690706	Dark Purple 	
	30 mm syringe filter 0.45 µm PTFE with pre-filter	13426826	10189524	Transparent Yellow 	
	30 mm syringe filter 0.2 µm PTFE with pre-filter	13416826	10608615	Transparent Blue 	
	30 mm syringe filter 0.45 µm PTFE (Hydrophobic)	15227498		Purple 	
	30 mm syringe filter 0.2 µm PTFE (Hydrophobic)	15207498		Green 	
	30 mm syringe filter 0.45 µm PVDF	13446916	10095634	Red 	
	30 mm syringe filter 0.45 µm nylon	13466916	10782707	White 	
	30 mm syringe filter 0.2 µm PVDF	13496896	10618615	Black 	
	30 mm syringe filter 0.45 µm regenerated cellulose	13577800	10017314	Light Brown 	
	30 mm syringe filter 0.2 µm regenerated cellulose	13597790	10313025	Granite 	
	30 mm syringe filter 0.45 µm polypropylene	13436916	10537835	White 	
	30 mm syringe filter 0.45 µm nylon	13406916	10057444	Transparent Green 	
	30 mm syringe filter 0.2 µm nylon	13476896	10198894	Light Purple 	
	30 mm syringe filter 0.20 µm polypropylene	13406906		Royal Blue 	
30 mm syringe filter 0.45 µm PTFE	13426826	10209134	Transparent Yellow 		
30 mm syringe filter 0.45 µm polypropylene	13436916	10772717	White 		

GE Healthcare/Whatman	GE Healthcare/Whatman	Millipore	PALL	Sartorius
GD/X	Puradisc	Millex	Acrodisc	Minisart
	6789-0404	SLHNR04NL	4484	
	6788-0402			
	6789-0402	SLGNR04NL		
	6783-0404	SLFHR04NL	4472	17820-K
	6783-0402	SLFGR04NL		17573-K2
	6779-0404	SLHVR04NL		
	6779-0402	SLGVR04NL	4415	
				17822-K
				17821-K
	6788-0404			
6870-1304	6789-1304	SLHN013NL	4426	17762-K
	6788-1302		4567	
	6782-1304			
6880-1304				
6880-1302				
6876-1302	6782-1302			
6870-1302	6789-1302	SLGN013NL	4427	1776B-K
6874-1304	6783-1304	SLFH013NL	4422	17574-K
6874-1302	6783-1302	SLFG013NL	4423	
		SLCR013NL		
		SLLGH13NL	MS-3301	
6872-1304	6779-1304	SLHV013NL	4457	
6872-1302	6779-1302	SLGV013NL	4455	
				17762-K
				17761-N
6784-1304	6788-1304		4563	
6870-2504	6750-2502	SLHN025NS	4438	1784C-K
6785-2502			4564	
6878-2504	6780-2504	SLHP033NS	4584	
6880-2504				17598-K
6880-2502				17597-K
6878-2502	6780-2502	SLGP033NS		
6890-2507				
6886-2512				
6870-2502	6750-2502	SLGN025NS	4436	1784B-K
6888-2527				
6874-2504	6784-2504	SLFH025NS	4219	17576-K
6874-2502	6784-2502	SLFG025NS	4225	17575-S
		SLLHH25NK		
		SLLHH25NK	MS-3201	
6872-2504		SLHV033NS	4408	
6872-2502		SLGV025NB	4406	
				17765-K
				17764-S
			4560	
6870-2504			4549	
6871-2502			4436	1784B-K
6878-2502			4307	
6874-2504			4303	
6878-2504			4559	

- Alternative parts are based on a direct technical comparison
- Part number alternatives are based upon closest pack quantity
- Inclusion of parts is no guarantee of identical performance

Syringes and centrifugal filters



All-plastic disposable syringes

- Disposable syringes with polyethylene barrels and polypropylene plungers;
- Two-part, all-plastic construction eliminates the need for rubber or synthetic plunger gaskets
- No silicone or oil lubricant is required in the barrel
- Choose Luer-Slip or Luer Lock syringes, in capacities ranging from 1 to 50 mL propylene plungers

	Capacity (mL)	Catalog No.	Quantity
Luer-Slip Syringes	1	10280655	100 pack
	3	10608435	100 pack
	5	10271245	100 pack
	10	10178894	100 pack
	20	10785126	100 pack
Luer Lock Syringes	3	10362725	100 pack
	5	10744366	100 pack
	10	11991553	100 pack
	20	10302685	100 pack



750 µL micro-centrifugal filters, non-sterile

- Filter volumes as low as 50 µL with low hold-up volume
- Filter volumes as low as 50 µL up to 750 µL with low hold-up volume
- Use with any laboratory microcentrifuge
- Virgin polypropylene filter housing with tapered 2 mL, capped receiver tube
- 10,000 × G maximum centrifugal force

Material	Pore Size (µm)	Catalog No.	Quantity
Cellulose Acetate	0.2	10639375	100 Pack
Cellulose Acetate	0.45	10743976	100 Pack
Nylon	0.2	10457234	100 Pack
Nylon	0.45	10129254	100 Pack
PVDF	0.2	10519555	100 Pack
PVDF	0.45	10169424	100 Pack
Regenerated Cellulose	0.2	11978846	100 Pack
Regenerated Cellulose	0.45	10179514	100 Pack
PTFE	0.2	10137404	100 Pack
PTFE	0.45	10459624	100 Pack



25 mL centrifugal filters, non-sterile

- Filter sample volumes up to 25 mL
- Virgin polypropylene filter housing with conical receiver
- Use with benchtop or floor model centrifuges
- 2,500 × G maximum centrifugal force

Material	Pore Size (µm)	Catalog No.	Quantity
Cellulose Acetate	0.2	13476786	100 Pack
Cellulose Acetate	0.45	12604843	100 Pack
Nylon	0.2	10638815	100 Pack
Nylon	0.45	10139534	100 Pack
PVDF	0.2	10669855	100 Pack
PVDF	0.45	11975693	100 Pack

Find out more at eu.fishersci.com/go/thermochrom

Austria: fishersci.at Belgium: fishersci.be Denmark: fishersci.dk
 Germany: fishersci.de Ireland: fishersci.ie Italy: fishersci.it
 Finland: fishersci.fi France: fishersci.fr Netherlands: fishersci.nl
 Norway: fishersci.no Portugal: fishersci.pt Spain: fishersci.es
 Sweden: fishersci.se Switzerland: fishersci.ch UK: fishersci.co.uk